



Flat Four 4 Hole Corner Gusset Plate 7.62 X 7.62 X 1.62 Inch 3-1/2" X 5-3/8"

Basic Information

- Place of Origin: Jiangsu, China
- Brand Name: HENG TONG
- Certification: ISO
- Model Number: L-06A
- Minimum Order Quantity: 500 pieces
- Price: \$0.80 - \$1.50/pieces
- Packaging Details: four hole corner gusset plate is packed in cartons, cartons packed in pallet.
- Supply Ability: 5000000 Piece/Pieces per Month



Product Specification

- Standard: AiSi, ASTM, Bs, DIN, GB, JIS
- Grade: Q235, 304, 316
- Shape: C Channel
- Application: Steel Structure Hanging
- Perforated Or Not: Is Perforated
- Product Name: Four Hole Corner Gusset Plate
- Item: Four Hole Corner Gusset Plate
- Material: Low-carbon Steel, Stainless Steel
- Surface Treatment: EG, HDG, Power Coated
- Technique: Hot Dipped Galvanized
- Type: Perforated
- Thickness: 6.0mm
- Name: Four Hole Corner Gusset Plate
- Size: 88x135mm
- Port: Shanghai

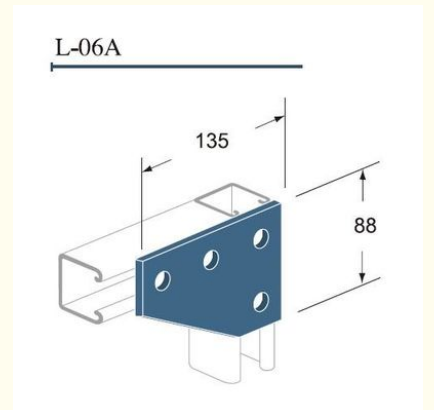

More Images



Product Description

four hole corner gusset plate

The fittings offer resistance to UV degradation, ensuring long-term performance in outdoor applications. They can be easily adjusted or repositioned without the need for specialized tools or equipment. Channel fittings are suitable for installations with high humidity or exposure to moisture, such as swimming pools or industrial washdown areas.

Product Name	four hole corner gusset plate
Thickness	6mm
Length	88mm
Width	135mm
RoHS	Yes
Material	Carbon steel Q235, stainless steel
Finish	standard finish is zinc-plated, available for hot dipped galvanized or powder coated
Applications	designed to fit with all 1-5/8" wide channels. Unless otherwise noted, two hole splice plates are manufactured from 1/4" thick carbon steel, 1-5/8" wide, all holes are 9/16" diameter, spaced 1-7/8" on center and 13/16" from the end.

Product Show

four hole corner gusset plate Detailed Photos



HENGTONG Catalog

Strut Channel Fitting include:

1. Flat plate fittings
2. Angle fittings
3. Z Shape fittings
4. U shape fittings
5. Wing shape fittings
6. Post base

平板连接件 Flat Plate Fittings

L-01

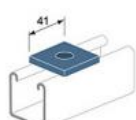

- Square Washer
- Standard Finish: Zinc-Plated
- Available for Stainless steel and Hot-Dipped Galvanized or powder coating Finish

规格 Part No	螺栓尺寸 Bolt Size	孔径(mm) Hole Dia.
L-01-08	M6, M8, 1/4-20UNC, 5/16-18UNC	9
L-01-10	M10, 3/8-16UNC	11
L-01-12	M12, 1/2-13UNC	14
L-01-16	M16, 5/8-11UNC	17.5

L-01-20	M20, 3/4-10UNC	20.5
L-01-22	7/8-9UNC	24

L-01A

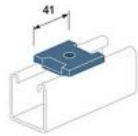

No-Twist Square Washer
 • Standard Finish: Zinc-Plated
 • Available for Stainless steel and Hot-Dipped Galvanized or powder coating Finish

規格 Part No	螺絲尺寸 Bolt Size	孔径 (mm) Hole Dia.
L-01A-08	M6, M8, 1/4-20UNC, 5/16-18UNC	9
L-01A-10	M10, 3/8-16UNC	11
L-01A-12	M12, 1/2-13UNC	14
L-01A-16	M16, 5/8-11UNC	17.5
L-01A-20	M20, 3/4-10UNC	20.5

L-02

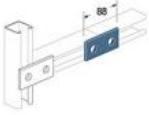

2 Hole Splice Plate
 • Standard Finish: Zinc-Plated
 • Available for Stainless steel and Hot-Dipped Galvanized or powder coating Finish

規格 Part No	螺絲尺寸 Bolt Size	孔径 (mm) Hole Dia.
L-02-10	M10, 3/8-16UNC	11
L-02-12	M12, 1/2-13UNC	14

L-02A



2 Hole Splice Plate
 • Standard Finish: Zinc-Plated
 • Available for Stainless steel and Hot-Dipped Galvanized or powder coating Finish

L-02B

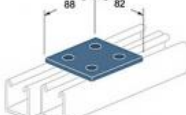

4 Hole Splice Plate
 • Standard Finish: Zinc-Plated
 • Available for Stainless steel and Hot-Dipped Galvanized or powder coating Finish

L-03

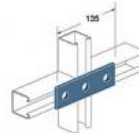

3 Hole Splice Plate
 • Standard Finish: Zinc-Plated
 • Available for Stainless steel and Hot-Dipped Galvanized or powder coating Finish

L-03A



2 Hole Splice Plate
 • Standard Finish: Zinc-Plated
 • Available for Stainless steel and Hot-Dipped Galvanized or powder coating Finish

L-04

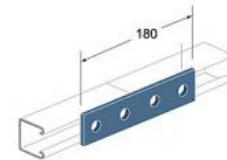

2 Hole Splice Plate
 • Standard Finish: Zinc-Plated
 • Available for Stainless steel and Hot-Dipped Galvanized or powder coating Finish

L-04A

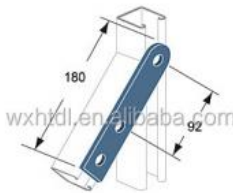

4 Hole Splice Plate
 • Standard Finish: Zinc-Plated
 • Available for Stainless steel and Hot-Dipped Galvanized or powder coating Finish

L-04B

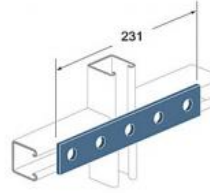

2 Hole Splice Plate
 • Standard Finish: Zinc-Plated
 • Available for Stainless steel and Hot-Dipped Galvanized or powder coating Finish

L-05

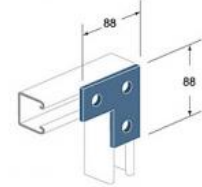

2 Hole Splice Plate
 • Standard Finish: Zinc-Plated
 • Available for Stainless steel and Hot-Dipped Galvanized or powder coating Finish

L-05A

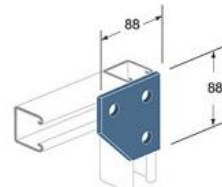

4 Hole Splice Plate
 • Standard Finish: Zinc-Plated
 • Available for Stainless steel and Hot-Dipped Galvanized or powder coating Finish

L-06

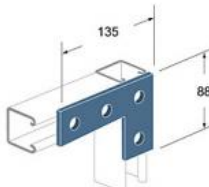

2 Hole Splice Plate
 • Standard Finish: Zinc-Plated
 • Available for Stainless steel and Hot-Dipped Galvanized or powder coating Finish

L-06A

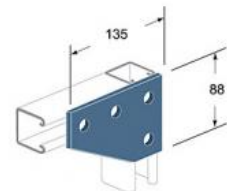

2 Hole Splice Plate
 • Standard Finish: Zinc-Plated
 • Available for Stainless steel and Hot-Dipped Galvanized or powder coating Finish

L-06B

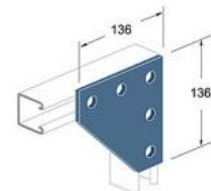

4 Hole Splice Plate
 • Standard Finish: Zinc-Plated
 • Available for Stainless steel and Hot-Dipped Galvanized or powder coating Finish

L-07

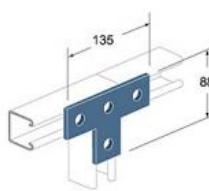

2 Hole Splice Plate
 • Standard Finish: Zinc-Plated
 • Available for Stainless steel and Hot-Dipped Galvanized or powder coating Finish

L-07A

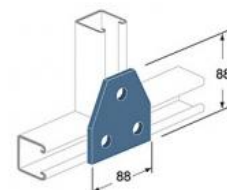

2 Hole Splice Plate
 • Standard Finish: Zinc-Plated
 • Available for Stainless steel and Hot-Dipped Galvanized or powder coating Finish

L-07B

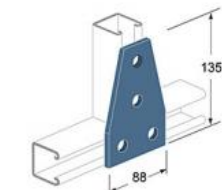

4 Hole Splice Plate
 • Standard Finish: Zinc-Plated
 • Available for Stainless steel and Hot-Dipped Galvanized or powder coating Finish

L-07C

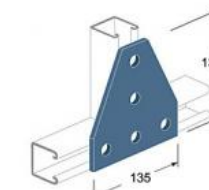

2 Hole Splice Plate
 • Standard Finish: Zinc-Plated
 • Available for Stainless steel and Hot-Dipped Galvanized or powder coating Finish

L-07D

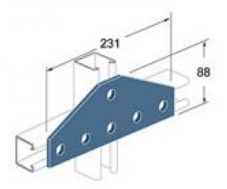

2 Hole Splice Plate
 • Standard Finish: Zinc-Plated
 • Available for Stainless steel and Hot-Dipped Galvanized or powder coating Finish

L-07E

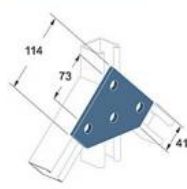

4 Hole Splice Plate
 • Standard Finish: Zinc-Plated
 • Available for Stainless steel and Hot-Dipped Galvanized or powder coating Finish

L-08

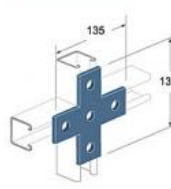

2 Hole Splice Plate
 • Standard Finish: Zinc-Plated
 • Available for Stainless steel and Hot-Dipped Galvanized or powder coating Finish

L-08A

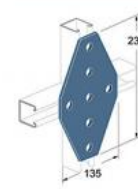

2 Hole Splice Plate
 • Standard Finish: Zinc-Plated
 • Available for Stainless steel and Hot-Dipped Galvanized or powder coating Finish

Packaging & Shipping

four hole corner gusset plate packaging details

Material in stock can be produced (procedure 5-20days) right away after pre-payment confirmation. COSCO Mearsk MSCship to worldwide for safe shipping, don't worry about package damage or loss. It takes about 15-40 days to worldwide, Please note us your contact details include your phone number for easy contacting from shipping company officer.

By sea	Shanghai port, Ningbo port or others
By air	Shanghai Pudong port
By express	DHL, TNT, FedEx, UPS etc



Application for four hole corner gusset plate



Company Information

Wuxi Hengtong Metal Framing System Co., Ltd(HENGTONG) is one of the well established firms in Wuxi for the past 20 years meeting the requirements of Pipe Supporting Systems. We have a good contact with domestic and foreign manufacturers and suppliers producing and supplying original branded pipe supporting materials. It provide kinds of quality and original products for clients. HENGTONG manufacture P41 series strut channels, U shape channels, angle steels, channel fittings, brackets, cantilever arms, beam clamps, pipe clamps etc. Our factory is located in Wuxi which is about 130km from Shanghai port, which is very convenient to deliver goods.



Why choose us?

1. Customized service is available according to the customers' requirement
2. OEM is available
3. High quality & competitive price

4. Good after-sale service

Payment Terms

payment terms for four hole corner gusset plate

	EXW	30% T/T in advance, paid the balance before shipment
T/T	FOB	
	CFR(C&F)	30% T/T in advance, paid the balance against copy of B/L
Payment Terms	CIF	
	L/C	L/C amount above 50,000 usd, we can accept L/C at sight
	West Union	Amount lower than 5000usd

Delivery time 10~45days after receiving payment

Contact Us

Company: Wuxi Hengtong Metal Framing System Co., Ltd
Address: No.6 East Dingxiang Road, Hudai Industry Zone, Wuxi City 214161, China

Contact: Vicky
Mob: +86-138 1228 2938
Tel: +86-510-6878 3383
Fax: +86-510-68783390
Web: <http://www.htstrut.com>



Wuxi Hengtong Metal Framing System Co., Ltd.



+86 15251535252



elinglu@htstrut.com



channel-fittings.com

No 6 East Dingxiang Road Hudai Industry Zone Wuxi City 214161 China